

24 WBL 01

Flashing Warning Beacon



Main features

- Universal application possibilities
- Suited for industrial environments
- Degree of protection IP54
- Sturdy metal housing
- Impact-proof lens

The 24 WBL 01 flashing warning beacon is used to visually signal alarm signals as well as incoming calls at intercom stations.

Call Signaling at Intercom Stations

The beacon will start to flash, as soon as the intercom station receives a call. The signaling will stop, as soon as the incoming call has been accepted or pre-programmed time has elapsed.

Alarm Signaling

The flashing warning beacon will be activated for the duration of the alarm. It can either be connected to an intercom station or the control exchange unit in order to control the beacon from there.

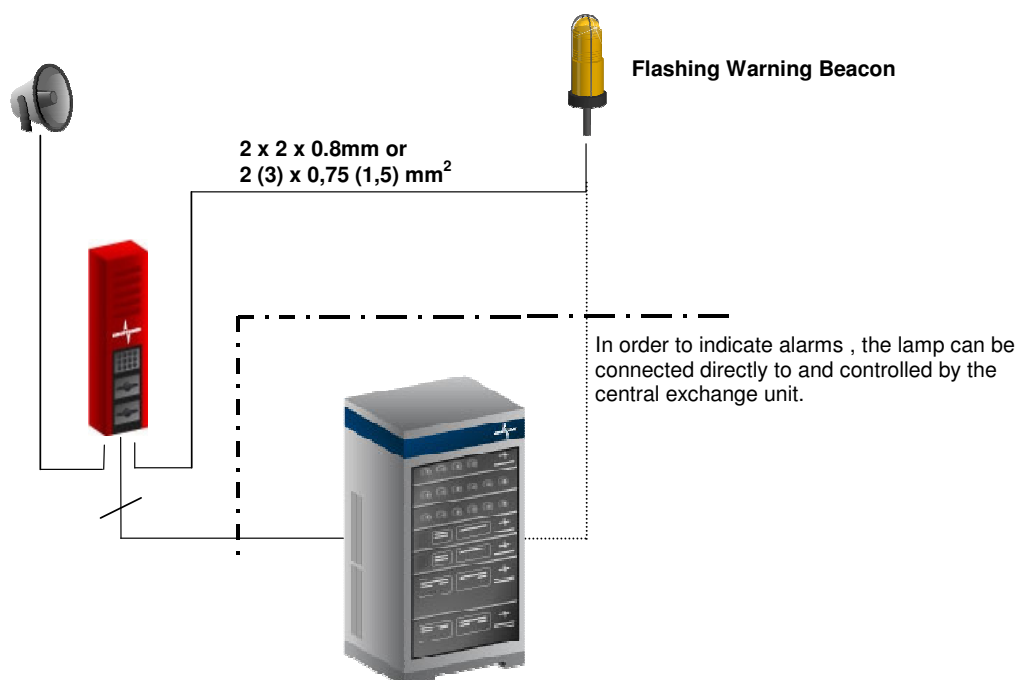

Figure 1: Application

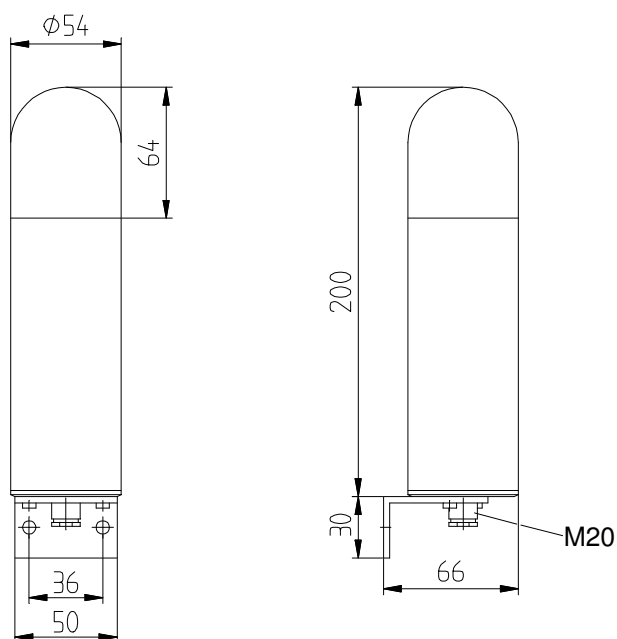

Figure 2: Dimensional drawing 24 WBL 01

Mechanical data

• Housing material	Aluminum
• Hood material	Polycarbonate (PC)
• Height x Width	200 mm x 54 mm (8" x 2")
• Cable gland	M20
• Weight	approx. 0.3 kg (approx. 3/4" lb)
• Colors	Orange, yellow, red (other colors on request)

Electrical data

• Operating voltage range	18 VDC to 35 VDC
• Current consumption	250 mA
• Flash energy	5 Joule
• Flash rate	1 Hz

Environmental requirements and standards

• Ambient temperature	-30 °C to +55 °C (-22 °F to 131 °F)
• Degree of protection	IP54 (vertical mounting)

INDUSTRONIC®

Industrie-Electronic GmbH & Co. KG
Carl-Jacob-Kolb-Weg 1
97877 Wertheim / Germany

Tel.: +49 9342 871-0
Fax: +49 9342 871-565

info@industronic.de
www.industronic.com